



Flow Control Modular Valve (Pressure and temperature compensated)

20 to 200ℓ/min
21,25,35MPa

Features

- ① This modular valve is used to control actuator speed and for other flow control valve applications.
- ② A wide range of models are available for A and B port control, A or B port control, and P port control.
- ③ A pressure compensation mechanism ensures that the control flow rate does not change, even when there is pressure fluctuation.
- ④ The control flow rate remains stable, even when oil temperature changes.
- ⑤ Maximum Operating Pressure : 21, 25, 35MPa {214, 255, 357kgf/cm²}

Specifications

Model No.	Nominal Diameter (Size)	Maximum Working Pressure MPa{kgf/cm ² }	Control Flow Rate ℓ/min	Check Valve Cracking pressure MPa{kgf/cm ² }	Weight kg	Gasket Surface Dimensions
OF-G01-P20-20	1/8	21 {214}	0.1 to 20(differential pressure: 7MPa{71.4kgf/cm ² }) 0.3 to 20(differential pressure:21MPa{214kgf/cm ² })	-	1.2	ISO 4401-03-02-0-05
OCF-G01-W40-X-30 A40 B40		25 {255}	0.1 to 40(differential pressure: 7MPa{71.4kgf/cm ² }) 0.5 to 40(differential pressure:25MPa{255kgf/cm ² })	0.08 {0.8}	1.7	
OCF-G01-W40-Y-30 A40 B40				0.08 {0.8}	1.5	
OF-G03-P60-J50	3/8	25 {255}	0.3 to 60(differential pressure: 7MPa{71.4kgf/cm ² }) 0.5 to 60(differential pressure:25MPa{255kgf/cm ² })	-	3.1	ISO 4401-05-04-0-05
OCF-G03-W60-X-J50 A60 B60			0.5 to 60(differential pressure: 7MPa{71.4kgf/cm ² }) 1 to 60(differential pressure:25MPa{255kgf/cm ² })	0.1 {1.0}	5.0	
OCF-G03-W60-Y-J50 A60 B60				0.1 {1.0}	4.6	
OFH-G04-W200-X-10 A200 B200	1/2	35 {357}	10 to 200(differential pressure:21MPa{214kgf/cm ² }) 15 to 200(differential pressure:25MPa{255kgf/cm ² }) 20 to 200(differential pressure:35MPa{357kgf/cm ² })	0.1 {1.0}	11.1	ISO 4401-07-06-0-05
OFH-G04-W200-Y-10 A200 B200					10.2	
					11.1	
					10.2	

● Handling

- ① For flow rate control, make sure that the pressure differential between the input port and output port is at least 1MPa {10.2kgf/cm²}. See the Flow Rate - Minimum Differential Pressure Characteristics for information about the OCF-G01 and OFF-04 maximum control flow rate.
- ② The control flow rate is increased by counter clockwise (leftward) rotation of the flow rate control knob.
- ③ Pressure rate control knob rotation resistance will increase as the pressure increases. However, do not use a spanner or other tool that fits around the knob to turn it. Instead, insert a 5mm hex spanner into the hex hole in the center of the knob and rotate it that way.
- ④ After adjusting the flow rate, fix it in place by turning the lock screw on the end of the knob to the right.
- ⑤ Note that a sub plate and installation bolts are not included. See pages D-90 through D-95 if these items are required.
- ⑥ 04 series modular valves do not have an L (DR₂) drain port, so they cannot be used in combination with pressure center type solenoid valves (D).
- ⑦ Flow rate fluctuation is ±5% within the temperature range of 20°C to 60°C.

Explanation of model No.

01, 03 size

OCF - G 03 - W 60 - Y - J50

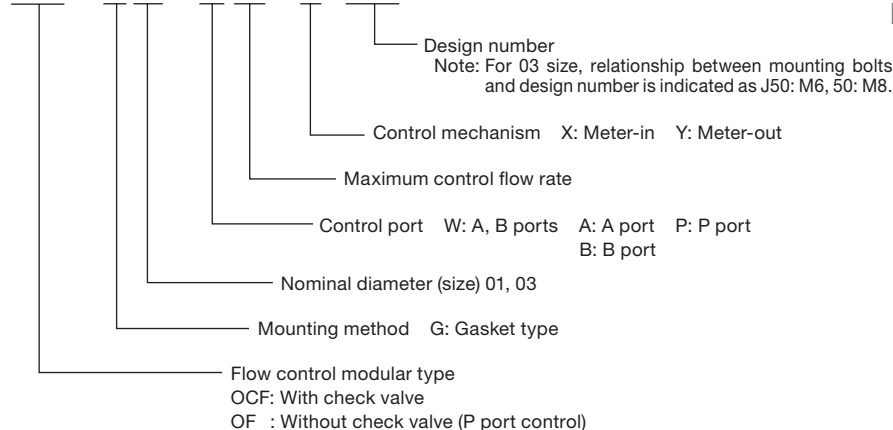

Explanation of model No.

04 size

OFH - G 04 - W 200 - Y - 10

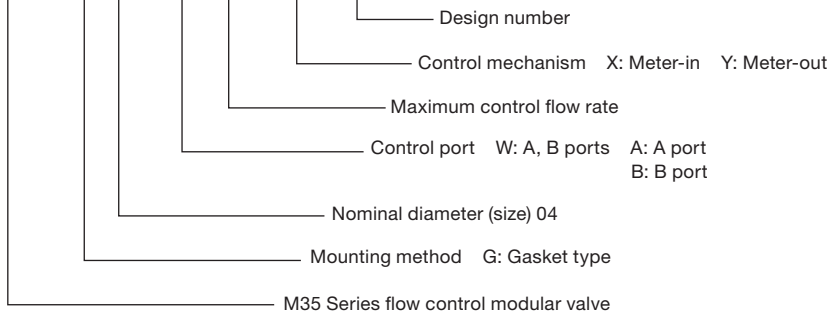

Installation Dimension Drawings

Note) The control flow rate is increased by counter clockwise (leftward) rotation of the flow rate control knob.

OF-G01-P20-20

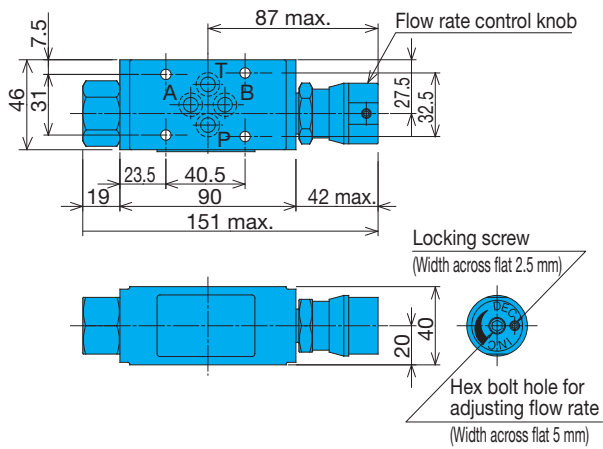

OCF-G01-W40-X/Y-30

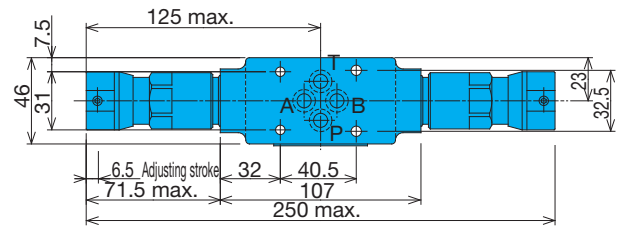

OCF-G01-A40-X/Y-30

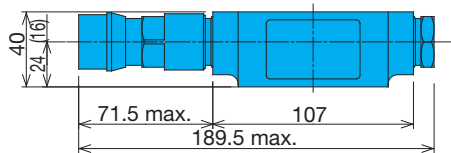

OCF-G01-B40-X/Y-30

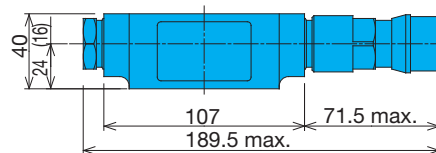

OF-G03-P60-J50

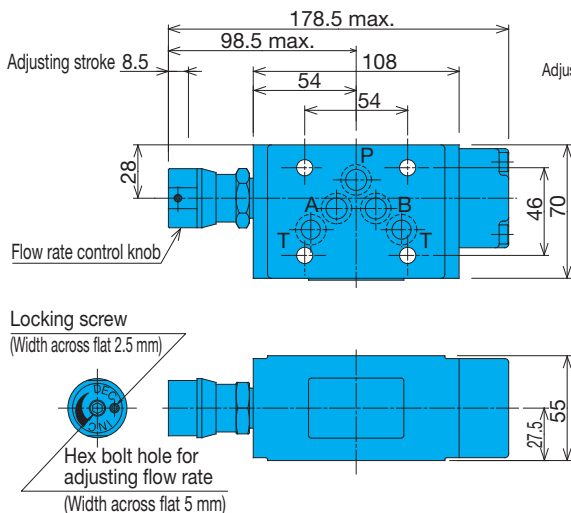

OCF-G03-W60-X/Y-J50

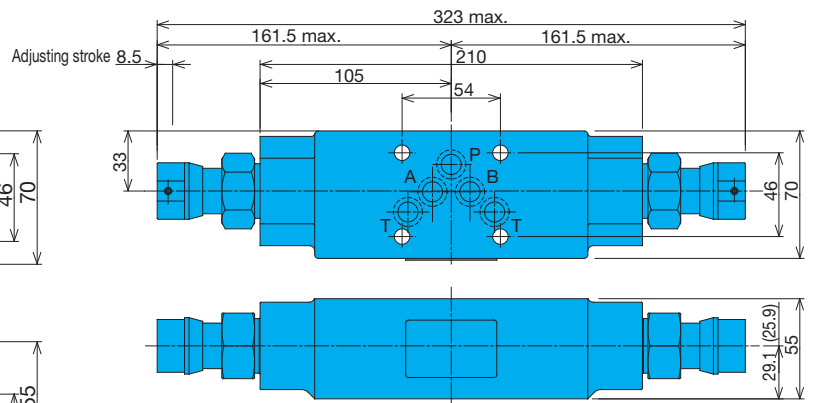

OCF-G03-A60-X/Y-J50

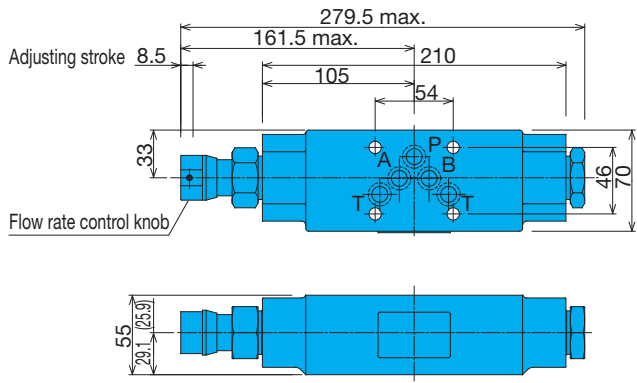

Note) Dimensions in the parentheses are for the OCF-G03-A60-X-J50.

OCF-G03-B60-X/Y-J50

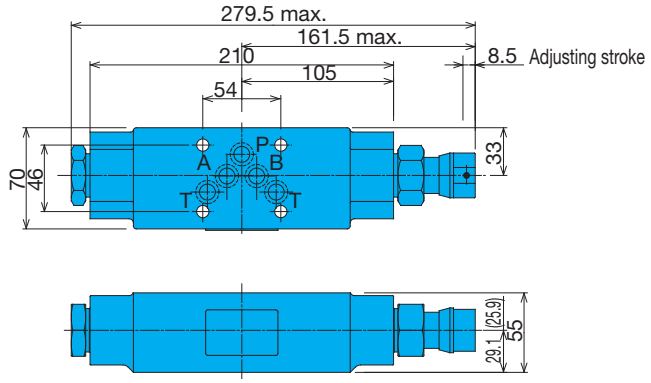

Note) Dimensions in the parentheses are for the OCF-G03-B60-X-J50.

OFH-G04-W200-X/Y-10

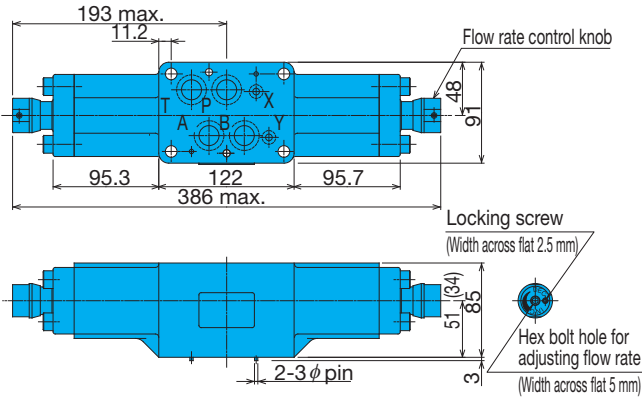

Note) Dimensions in the parentheses are for the OFH-G04-W200-X-10.

OFH-G04-A200-X/Y-10

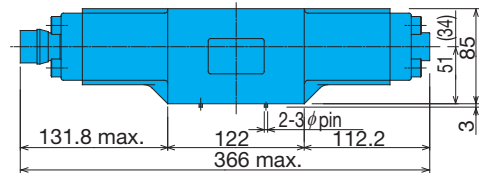

Note) Dimensions in the parentheses are for the OCF-G04-A200-X-10.

OFH-G04-B200-X/Y-10

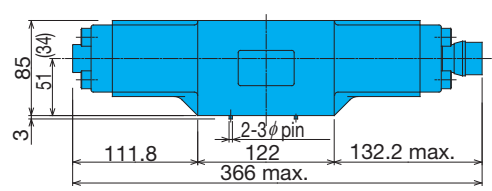

Note) Dimensions in the parentheses are for the OFH-G04-B200-X-10.

Performance Curves

Hydraulic Operating Fluid Kinematic Viscosity 32mm²/s

Pressure Loss Characteristics

OF-G01-P20-20

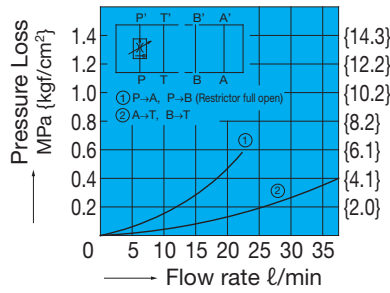

OCF-G01-A40-Y-30

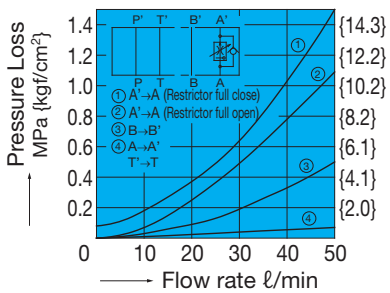

OF-G03-P60-J50

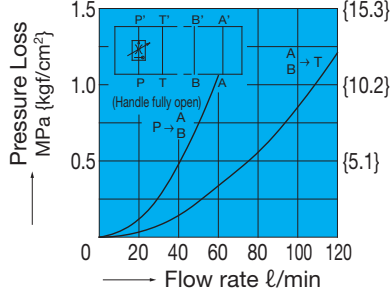

OCF-G03-W60-Y-J50

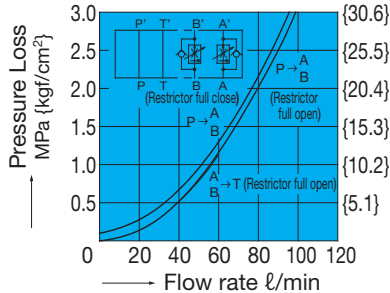

OFH-G04-W200-Y-10

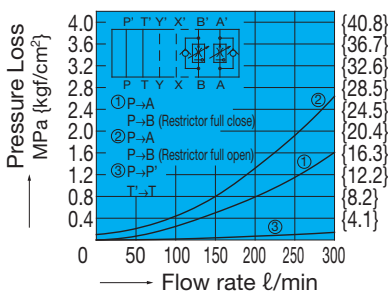

Pressure - Control Flow Rate Characteristics

OF-G01-P20-20

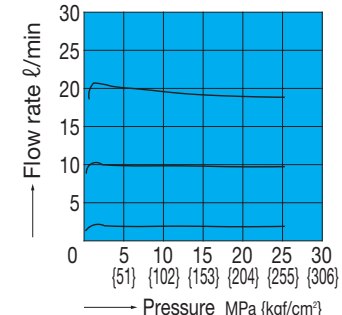

OCF-G01-*40-*-30

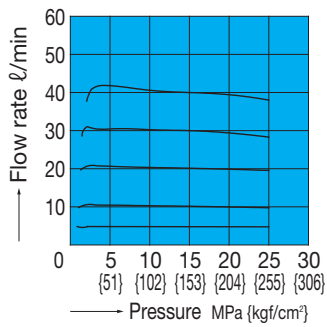

OF-G03-P60-J50

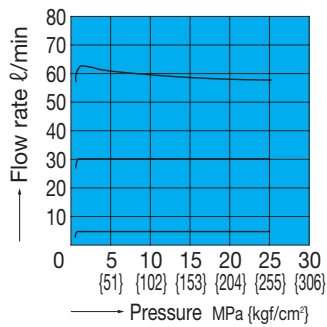

OCF-G03-W60-*-J50

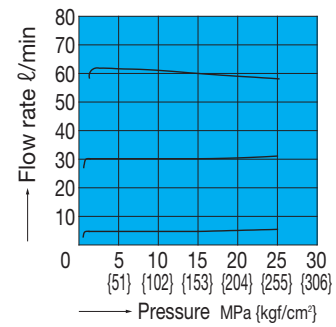

Oil Temperature – Control Flow Rate Characteristics

OFH-G04-W200-*-10

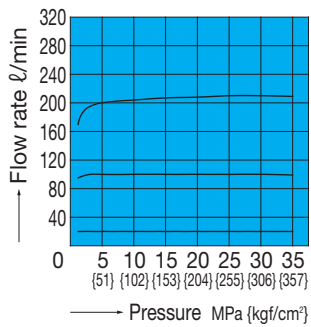

OF-G01-P20-20

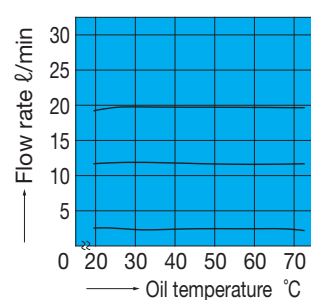

OCF-G01-*40-*-30

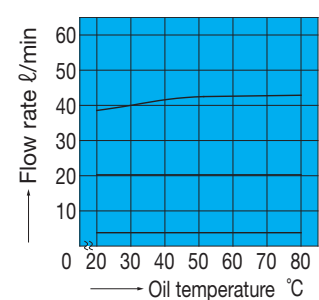

OF-G03-P60-J50

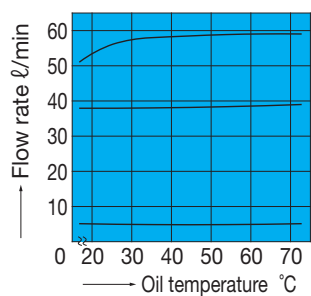

OCF-G03-W60-*-J50

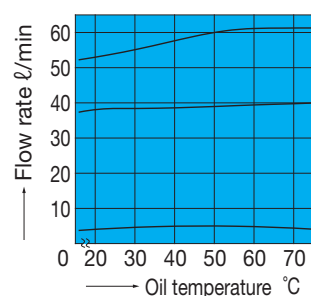

OFH-G04-W200-*-10

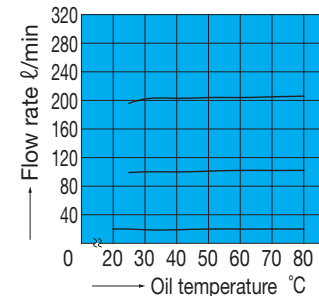

Flow Rate – Minimum Differential Pressure Characteristics

OCF-G01-*40-*-30

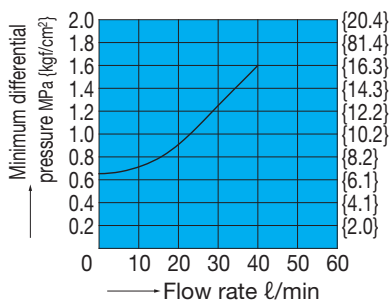

OFH-G04-W200-Y-10

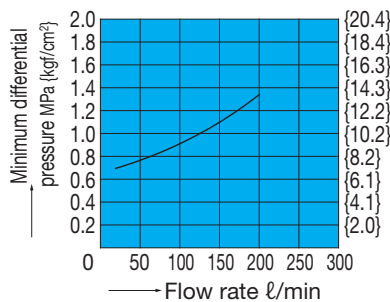

Cross-sectional Drawings

OF-G01-P20-20

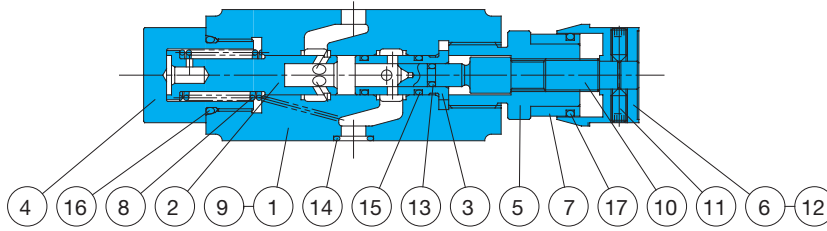

Seal Part List (Kit Model Number BFBS-01FP-0A)

Part No.	Part Name	Part Number	Q'ty	
				P
13	O-ring	NBR-90 P4	1	
14	O-ring	AS568-012(NBR-90)	4	
15	O-ring	NBR-90 P9	2	
16	O-ring	NBR-90 P20	1	
17	O-ring	NBR-70-1 P21	1	

Note) The materials and hardness of the O-ring conform with JIS B2401.

Part No.	Part Name
1	Body
2	Piston
3	Sleeve
4	Bushing
5	Retainer
6	Knob
7	Dial
8	Spring
9	Plate
10	Screw
11	Screw
12	Screw
13	O-ring
14	O-ring
15	O-ring
16	O-ring
17	O-ring

OCF-G01-A40-Y-30

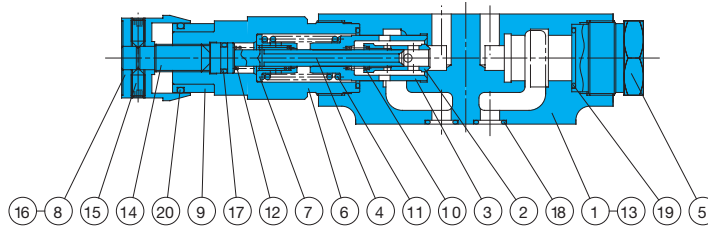

Seal Part List (Kit Model Number BFCS-01CF*-0A)

Part No.	Part Name	Part Number	Q'ty		
			W	A	B
17	O-ring	NBR-70-1 P8	2	1	1
18	O-ring	AS568-012(NBR-90)	4	4	4
19	O-ring	AS568-018(NBR-90)	2	2	2
20	O-ring	NBR-70-1 P21	1	1	1

Note) 1. The materials and hardness of the O-ring conform with JIS B2401.

2. Specify W, A, or B for the asterisk (*) in the kit model number.

Part No.	Part Name
1	Body
2	Throttle
3	Piston
4	Rod
5	Bushing
6	Retainer
7	Guide
8	Knob
9	Dial
10	Spring
11	Spring
12	Spring
13	Plate
14	Screw
15	Screw
16	Screw
17	O-ring
18	O-ring
19	O-ring
20	O-ring

OF-G03-P60-J50

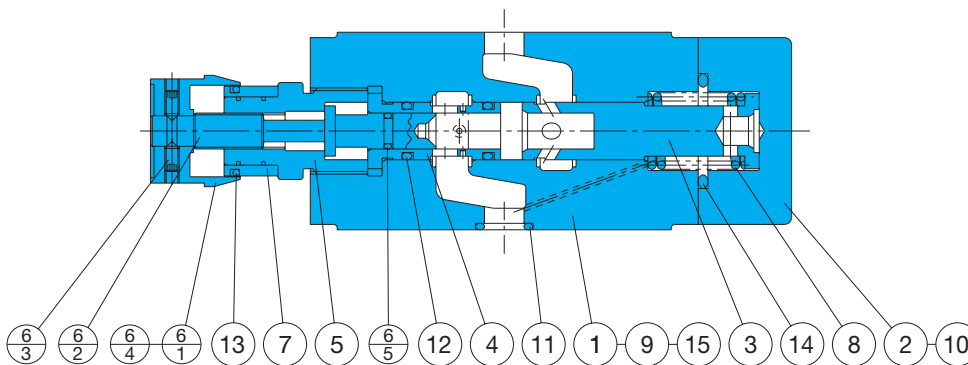

Seal Part List (Kit Model Number BFES-03FP)

Part No.	Part Name	Part Number	Q'ty	
				PC
6.s	O-ring	NBR-70-1 P7	1	
11	O-ring	AS568-014(NBR-90)	5	
12	O-ring	NBR-90 P12	2	
13	O-ring	NBR-70-1 P21	1	
14	O-ring	NBR-90 P26	1	

Note) The materials and hardness of the O-ring conform with JIS B2401.

Part No.	Part Name
1	Body
2	Cover
3	Piston
4	Sleeve
5	Retainer
6	Screw kit
6.1	Knob
6.2	Screw
6.3	Screw
6.4	Screw
6.5	O-ring
7	Dial
8	Spring
9	Plate
10	Screw
11	O-ring
12	O-ring
13	O-ring
14	O-ring
15	Pin

OCF-G03-A60-Y-J50

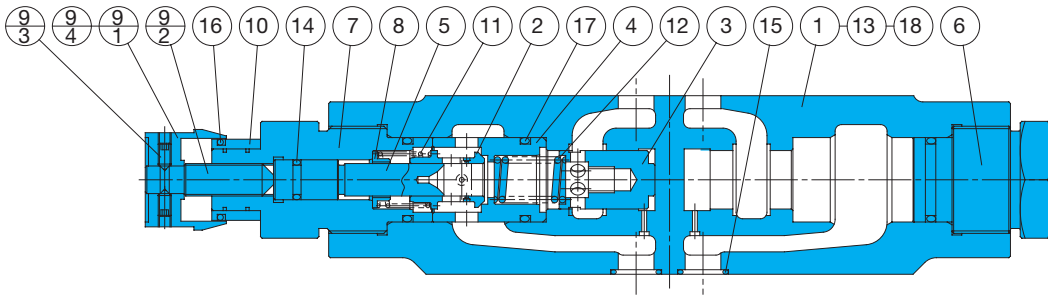

Part No.	Part Name
1	Body
2	Throttle
3	Piston
4	Sleeve
5	Rod
6	Bushing
7	Retainer
8	Guide
9	Screw kit
9-1	Knob
9-2	Screw
9-3	Screw
9-4	Screw
10	Dial
11	Spring
12	Spring
13	Plate
14	O-ring
15	O-ring
16	O-ring
17	O-ring
18	Pin

Seal Part List (Kit Model Number BFES-03CF*)

Part No.	Part Name	Part Number	Q'ty		
			W	A	B
14	O-ring	NBR-70-1 P10	2	1	1
15	O-ring	AS568-014(NBR-90)	5	5	5
16	O-ring	NBR-70-1 P21	2	1	1
17	O-ring	NBR-90 P22	4	3	3

Note) 1. The materials and hardness of the O-ring conform with JIS B2401.
 2. Specify W, A, or B for the asterisk (*) in the kit model number.

OFH-G04-A200-Y-10

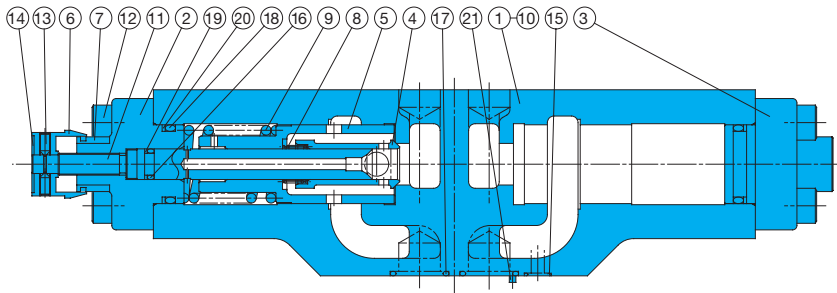

Part No.	Part Name
1	Body
2	Cover
3	Cover
4	Throttle
5	Piston
6	Knob
7	Dial
8	Spring
9	Spring
10	Plate
11	Screw
12	Screw
13	Screw
14	Screw
15	O-ring
16	O-ring
17	O-ring
18	O-ring
19	Backup ring
20	Backup ring
21	Pin

Seal Part List (Kit Model Number BFKS-04CF*)

Part No.	Part Name	Part Number	Q'ty		
			W	A	B
15	O-ring	AS568-012(NBR-90)	2	2	2
16	O-ring	NBR-90 P10A	2	1	1
17	O-ring	AS568-118(NBR-90)	4	4	4
18	O-ring	NBR-90 P30	2	2	2
19	Backup ring	T2-P10A	2	1	1
20	Backup ring	T2-P30	2	2	2

Note) 1. The materials and hardness of the O-ring conform with JIS B2401.
 2. Backup ring indicates JIS B 2407-T2-**.
 3. Specify W, A, or B for the asterisk (*) in the kit model number.