

### Electro-hydraulic Proportional Relief Valve

150 to 320ℓ/min  
0.3 to 35MPa

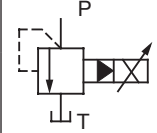

### Features

This valve combines a compact, high-performance electro-hydraulic proportional pilot relief valve and balanced piston type relief valve to provide pressure control in proportion to input current.

Throughput volume and oil temperature fluctuation has little effect on control pressure, so this valve provides open loop control of even complex pressures (forces).

#### ● Handling

##### 1 Air Bleeding

To enable proper pressure control, loosen the air vent when starting up the pump in order to bleed any air from the pump, and fill the inside of the solenoid with hydraulic operating fluid.

##### 2 Manual Pressure Adjusting Screw

For the initial adjustment or when there is no input current to the valve due to an electrical problem or some other reason, valve pressure can be increased by rotating the manual adjustment screw clockwise (rightward). Normally, the manual adjusting screw should be rotated back fully to the left (counterclockwise) and secured with the lock nut.

##### 3 Tank Port Back Pressure

Make sure that tank port back pressure is as small as possible; no greater than 0.2MPa {2kgf/cm<sup>2</sup>}.

##### 4 Safety Valve Setting Pressure

The safety valve is set to maximum adjustment pressure plus 1.5 to 2.0MPa {15.3 to 20.4kgf/cm<sup>2</sup>}. When actually using the valve, adjust in accordance with actual pressure.

##### 5 Bundled Accessories (Valve Mounting Bolts)

### Specifications

Item	Model No.	ER-G03-*21	ER-G06-*21
Maximum Flow Rate ℓ/min		150	320
Pressure Control Range MPa{kgf/cm <sup>2</sup> }		B:0.3 to 2.5{ 3.1 to 25.5}(Note 1) 1:0.7 to 7 { 7.1 to 71 } 2:1.0 to 14 {10 to 143 } 3:1.5 to 21 {15.3 to 214 } 4:1.5 to 28 {15.3 to 286 } 5:2.0 to 35 {20 to 357 }	
Rated Current mA		800	
Coil Resistance Ω		20 (20°C)	
Hysteresis %		3 max. (Note 2)	
Minimum Relief Flow Rate ℓ/min		5	8
Weight kg		6.0	7.1

Note) 1. G03 type only Flow rate: 40ℓ/min

2. Value when a Nachi-Fujikoshi special amplifier is used (with dithering).

### Explanation of model No.

ER - G 03 - 3 - 21

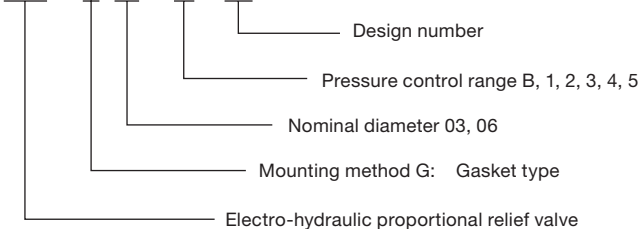

Model No.	Bolt Size	Q'ty	Tightening Torque N-m{kgf·cm}
ER-G03	M12×50ℓ	4	75 to 95{ 765 to 970}
ER-G06	M16×60ℓ	4	190 to 235{1940 to 2400}

6 Use an operating fluid that conforms to the both of the following. Oil Temperature: -20 to 70°C Kinematic Viscosity: 12 to 400mm<sup>2</sup>/s. The recommended kinematic viscosity range is 15 to 60mm<sup>2</sup>/s.

### Installation Dimension Drawings

ER-G\*\*-\*21

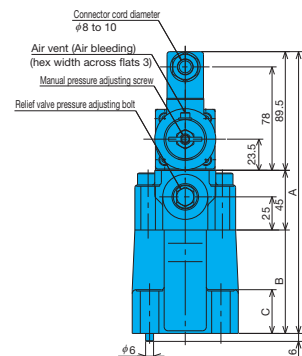
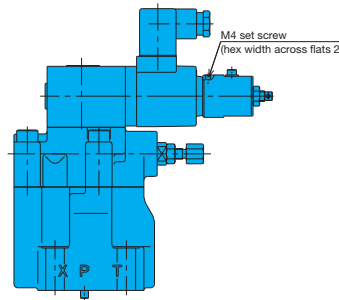
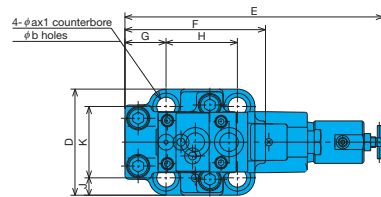

The gasket surface dimensions comply with the ISO standard shown below.

G03...ISO 6264-06-09-0-97  
G06...ISO 6264-08-13-0-97

Model No.	A	B	C	D	E	F	G	H	J	K	a	b
ER-G03	212.5	78	33	80	194.8	106	31	53.8	13.1	53.8	20	14
ER-G06	217.5	83	37	100	203.8	119	37	66.7	15	70	26	17.5

Sub Plate (Maximum Operating Pressure: 25MPa)  
MRI-03\*-10

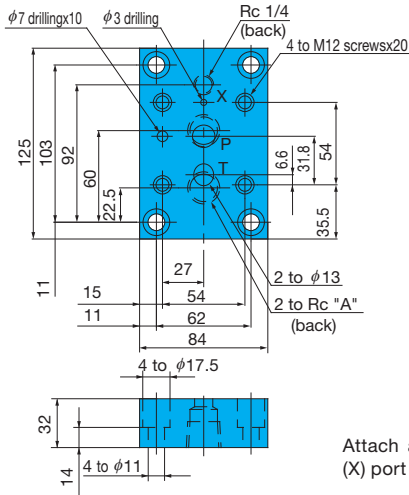

Attach a plug when the vent (X) port is not used.

MRI-06\*-10

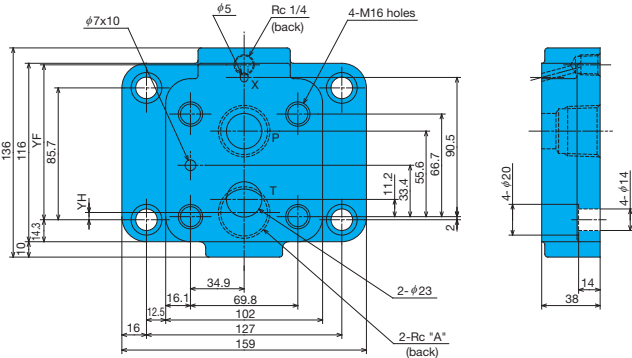

Model No.	A
MRI-03-10	3/8
MRI-03X-10	1/2
MRI-06-10	3/4
MRI-06X-10	1

Model No.	YF	YH
MRI-06-10	92.5	13.2
MRI-06X-10	100.7	4.7

## Performance Curves

Flow Rate – Pressure Characteristics  
ER-G06\*-21

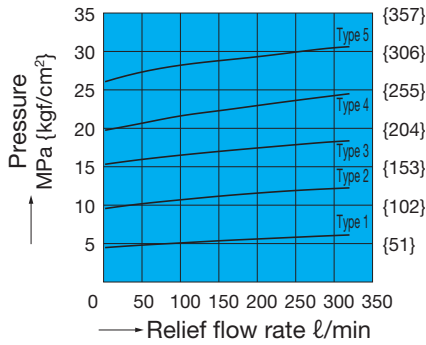

Hydraulic Operating Fluid Kinematic Viscosity 32mm²/s

Input Current – Pressure Characteristics  
ER-G06\*-21

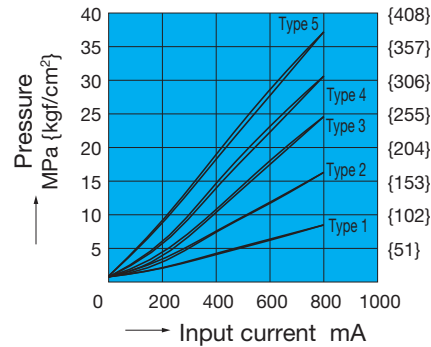

## Cross-sectional Drawing

ER-G\*\*-\*-21

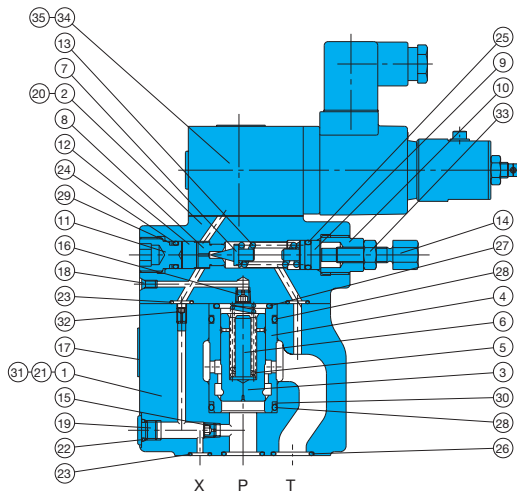

ER Valve Built-in Pilot Relief Valve List

Model No.	Built-in Pilot Relief Valve
ER-G03-B-21	EPR-G01-B-0011S-12
1	1-0011S-12
2	2-1313S-12
3	3-1212S-12
4	4-1111S-12
5	5-1010S-12
ER-G06-1-21	EPR-G01-1-0011S-12
2	2-1313S-12
3	3-1212S-12
4	4-1111S-12
5	5-1010S-12

Seal Part List (Kit Model Number REBS-\*\*)

Part No.	Part Name	Nominal Diameter/Part Number		Q'ty
		G03	G06	
22	O-ring	NBR-90 P8	NBR-90 P8	1
23	O-ring	NBR-90 P9	NBR-90 P9	3
24	O-ring	NBR-90 P10A	NBR-90 P10A	1
25	O-ring	NBR-70-1 P11	NBR-70-1 P11	1
26	O-ring	NBR-90 P18	NBR-90 P28	2
27	O-ring	NBR-90 G25	NBR-90 P28	1
28	O-ring	NBR-90 G30	NBR-90 P32	2
29	Backup ring	T2-P10A	T2-P10A	1
30	Backup ring	T2-G30	T2-P32	1

Note) 1. The materials and hardness of the O-ring conforms with JIS B2401.  
2. For the \*\* part of the kit number, specify the valve size (G03, G06).  
3. EPR-G01 pilot valve seal is available separately. See page I-3 for more information.

Part No.	Part Name	Part No.	Part Name
1	Body	18	Plug
2	Cover	19	Plug
3	Poppet	20	Screw
4	Sleeve	21	Pin
5	Spring	22	O-ring
6	Spacer	23	O-ring
7	Poppet	24	O-ring
8	Seat	25	O-ring
9	Plunger	26	O-ring
10	Retainer	27	O-ring
11	Plug	28	O-ring
12	Collar	29	Backup ring
13	Spring	30	Backup ring
14	Handle	31	Screw
15	Orifice	32	Choke
16	Orifice	33	Nut
17	Plate	34	Pilot relief valve
		35	Screw